

# User Manual ZLIDISPLAY



## INDEX

1. Introduction .....	2
2. How to connect the display to a single battery .....	3
3. How to connect the display to multiple batteries .....	3
4. ON/OFF button + Programming .....	4
5. Working during charging .....	5
6. Working during discharge .....	5
7. What is the purpose, how does blocking relay work and its technical characteristics .....	6
8. Mobile app .....	7
9. How to connect the app with ZLIDISPLAY .....	7
10. How to program the number of batteries from the app .....	7
11. How to update the firmware of ZLIDISPLAY .....	7
12. Parallel management .....	7
13. Error 1 .....	8
14. Error 2 .....	8
15. Error 3 .....	8
16. Error 4 .....	9
17. Accessories .....	9

## 1. INTRODUCTION

ZLIDISPLAY allows to show the basic parameters of the battery or battery pack to which it is connected:

- ▶ State of charge o S.o.C.
- ▶ Total voltage
- ▶ Charging or discharging current
- ▶ Maximum internal temperature
- ▶ Remaining autonomy according to discharge current

Direct communication with BMS makes it a very precise and essential accessory for knowing the state of the battery..

**NB: ZLIDISPLAY works exclusively with Zenith Lithium batteries.**

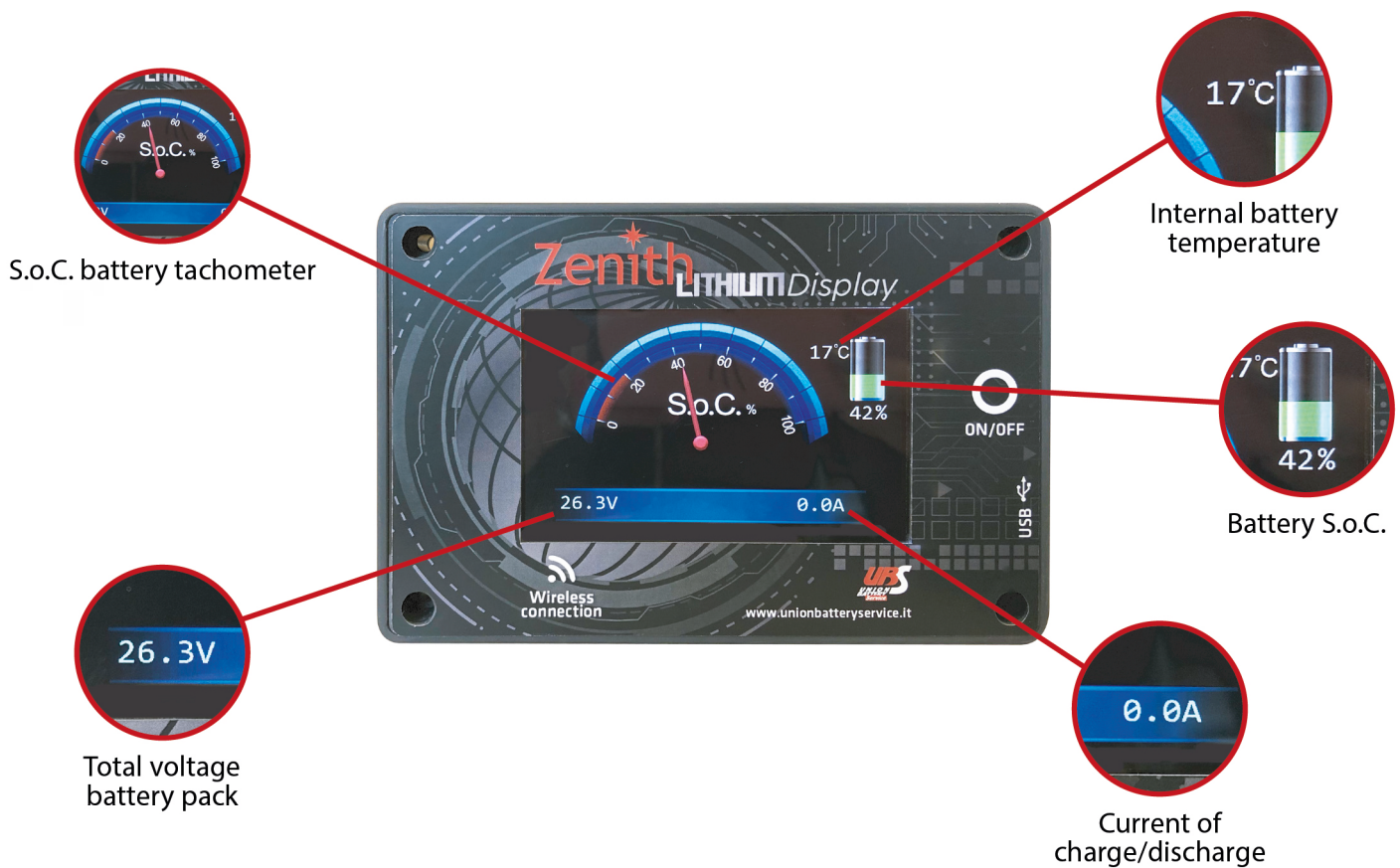

Model	Compatibility with ZLIDISPLAY	Parallel Management
ZLI012035	✓	✗
ZLI012051	✓	✗
ZLI012100	✓	✓ (max 4)
ZLI024036	✓	✗
ZLI024065	✓	✓ (max 10)
ZLI024070	✓	✓ (max 10)
ZLI024100	✓	✓ (max 10)
ZLI036065	✓	✓ (max 10)
ZLI036065.INOX	✓	✓ (max 10)
ZLI048060	✓	✓ (max 10)

## 2. HOW TO CONNECT THE DISPLAY TO THE BATTERY

On the back of the display and the battery have the same RS485 communication port. It will be necessary the appropriate **ZLIDISPCABx** cable in order to connect both devices.

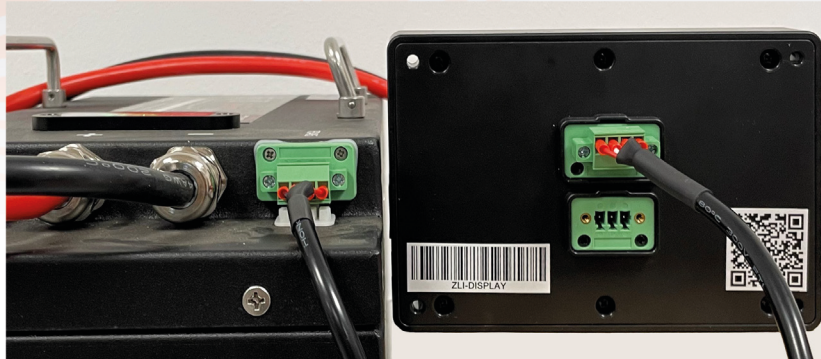

**NB: the display only works when the battery is switched on.**

### VIDEO TUTORIAL

## 3. HOW TO CONNECT THE DISPLAY TO MULTIPLE BATTERY

In case of several batteries connected in parallel, it is necessary to connect them to the display via the "ZLISWITCH" (see the table below or the data sheets of the batteries to see the maximum number of parallels that can be made).

Connection diagram:

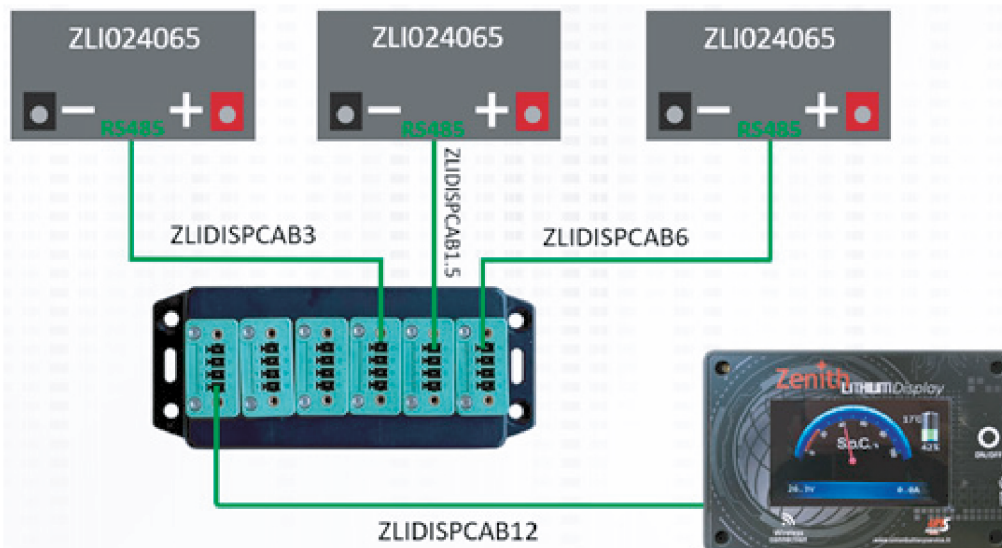

**NB: all the data shown on the display will relate to the entire battery pack to which it is connected.**

### VIDEO TUTORIAL

## 4. ON/OFF BUTTON + PROGRAMMING

The ON/OFF button, in addition to turning the display on and off, also used to program the number of batteries connected to it (parallel connection).

To turn the display on or off, hold the ON/OFF button for about 5 seconds.

To program the number of batteries, follow this procedure:

1. Number each battery using the dip switches located on the top of each battery.

Follow this diagram for the numbering:

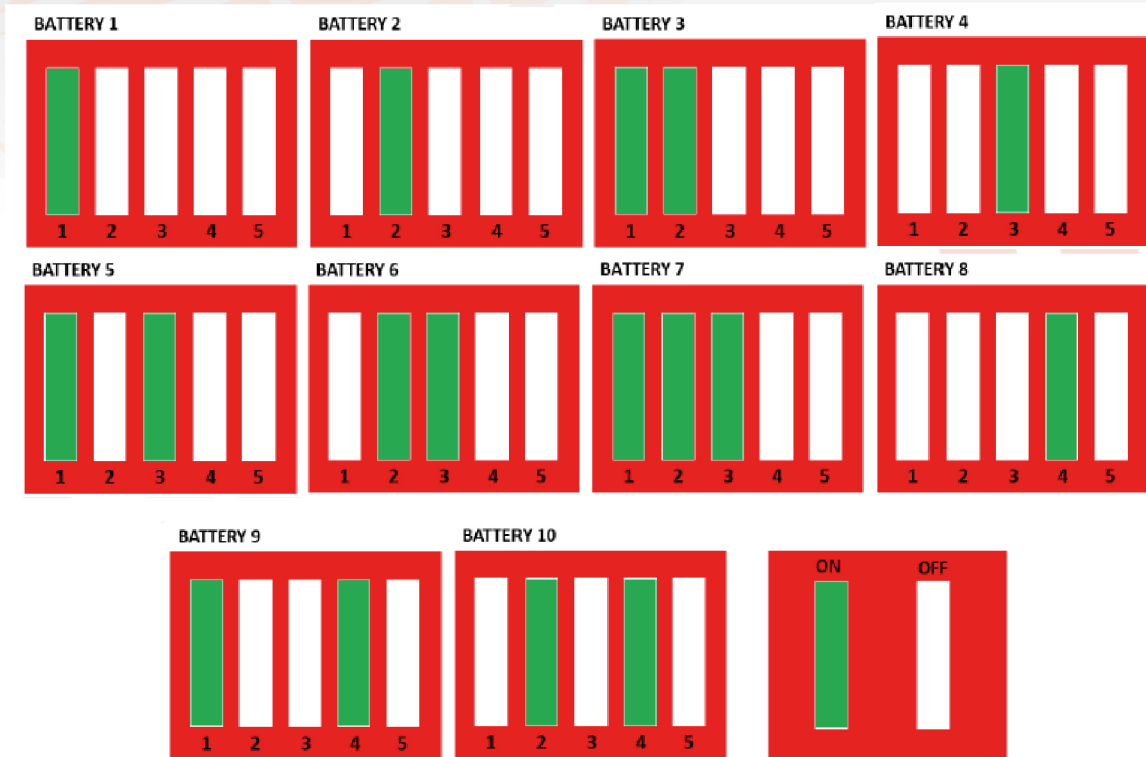

**NB: the display works correctly only if the batteries to which it is connected are numbered via dip-switch.**

2. Keep the ON/OFF button pressed for about 20 seconds (even if the display switches off, carry on keeping it pressed) until this screen appears:



3. Press the ON/OFF button to select the correct number of batteries and then hold it for about 5 seconds to confirm your choice. If the number of batteries is not confirmed after 5 seconds, the display will automatically exit programming and will not save the set value.

**NB: To carry out the programming it is necessary that the battery or the battery pack to which the display is connected is not in function (no charging or discharging). The number of batteries set on the display must be equal to the number of batteries that is connected.**

It is possible to program via the app by following the point nr. 10 or the [VIDEO TUTORIAL](#)

## 5. WORKING DURING CHARGING

"Charging" will appear on the display during charging phase and the charging current will be indicated at the bottom right corner.

After 2 consecutive minutes in the charging phase, the display automatically goes into stand-by mode. Press and hold the ON/OFF button for about 5 seconds to switch it on again or discharge the battery.



## 6. WORKING DURING DISCHARGE

"Discharging" will appear on the display during the discharging phase, the discharge current will be indicated at the bottom right corner and in the centre there will be the remaining autonomy time depending on the discharge current (if the remaining autonomy is more than 100 hours, the display will show "TIME --:--"). During this phase the display will never go into stand-by mode but it will be possible to switch it off by pressing and holding the ON/OFF button.

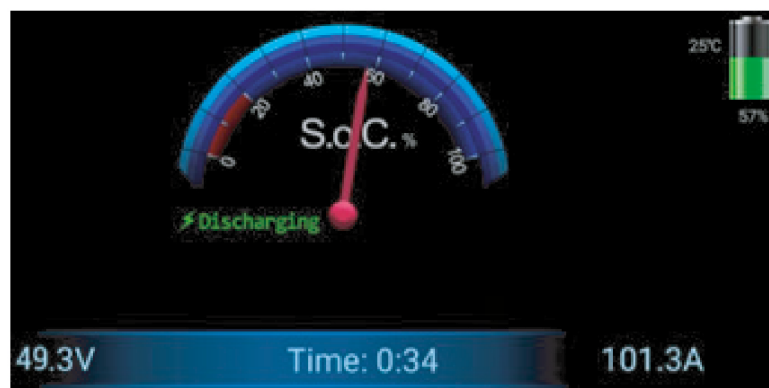

As soon as the S.o.C. reaches 20% the battery icon will change from green to red.

As soon as the S.o.C. reaches 10% the display will start flashing.

On models ZLI012035, ZLI012051 and ZLI024036 the display will switch off until the battery will put in charge, in case of full discharge (S.o.C. = 0%).

On all the other models it will remain on and continue to flash.

## 7. WHAT IS THE PURPOSE, HOW DOES BLOCKING RELAY WORK AND WHAT ARE ITS TECHNICAL CHARACTERISTICS

During discharging, when the S.o.C. of the battery falls below 20%, the blocking relay is activated. It is deactivated when during the charging of the battery, the S.o.C. reaches and exceeds 50% (the two values are not programmable).

The block relay is used to disable one or more vehicle functions.

When the lock relay is active, "**Lock Relay**" appears on the display.

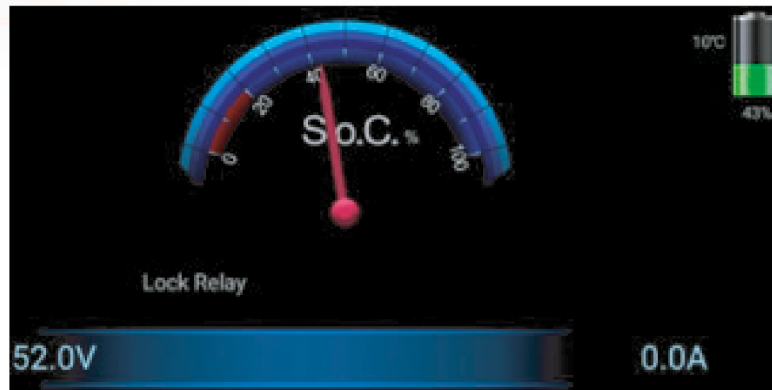

This is the connection diagram:

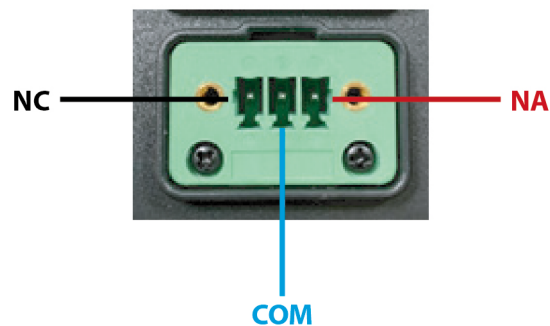

Specifications: 1A 60Vdc max

## 8. MOBILE PHONE APP

The app allows you to view the same information of the display and to update the firmware remotely. To download the app for mobile phones or tablets (only with Android operating system 9 onwards) [click here](#). To use it, it is necessary to activate geolocation and bluetooth (range: approx. 15m).

**NB: the app may be subject to updates, please check our website for the latest version**

### VIDEO TUTORIAL

## 9. HOW TO MATCH THE APP TO THE ZLIDISPLAY

1. Open "ZENITH LITHIUM DISPLAY" app on your phone/tablet.
2. Press on the three dots at the top right and select "**Select BMS Device**".
3. Select "ZLI DISPLAY" and wait for the two devices to communicate.
4. Once the connection is complete, you will be able to view the display data on your phone/tablet.

**NB: As long as the two devices remain connected, the screen will display this symbol:** 

## 10. HOW TO PROGRAM THE NUMBER OF BATTERIES FROM THE APP

1. Open the "ZENITH LITHIUM DISPLAY" app on your phone/tablet.
2. Press on the three dots at the top right and select "**Set Battery Quantity**".
3. Press on the bar and write the number of connected batteries (ZLIDISPLAY is always set for 1 battery).
4. Press "**SAVE**" to save the selected number.
5. The app will automatically return to the main screen with the saved settings.

## 11. HOW TO UPDATE THE ZLIDISPLAY FIRMWARE

**NB: FW updates will always be communicated directly by Union Battery Service or through its distributors.**

1. Open "ZENITH LITHIUM DISPLAY" app on your phone/tablet.
2. Press on the three dots at the top right and select "**Firmware Upgrade**".
3. Press "**SELECT**" and select the correct file.
4. Press "**UPGRADE**" to start downloading the firmware (it may take a few minutes).
5. When the update is complete, the app will automatically return to the start screen and you will need to reconnect to the display.

### VIDEO TUTORIAL

## 12. PARALLEL MANAGEMENT

The ZLIDISPLAY manages also the parallel connection of Zenith Lithium batteries (except ZLI012035, ZLI012051 and ZLI024036).

To see how to connect Zenith batteries (via ZLISWITCH) in parallel [click here](#).

After the connection procedure, it is possible to connect the display to the battery pack.

The ZLIDISPLAY will always provide the same information and manage the errors related to the parallel connection.

**NB: these errors only serve to make the operator understand that there is a problem in the battery pack, they DO NOT block or modify operation.**

### 13. ERROR 1

Error 1 appears only when there are two or more batteries of different capacities connected in parallel (ex. ZLI024065 connected with ZLI024100).

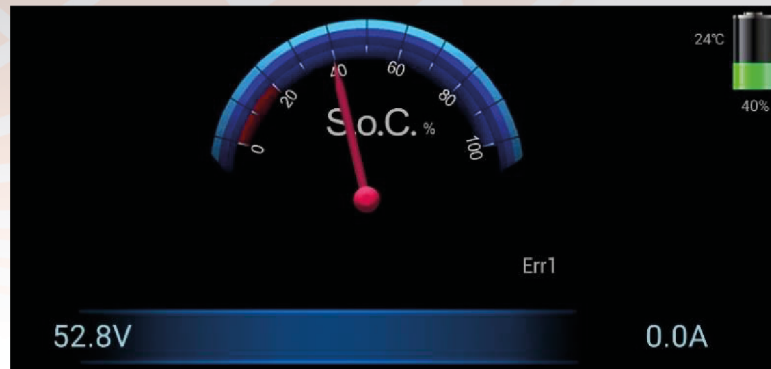

### 14. ERROR 2

Error 2 appears when the number of connected batteries is different from the number programmed on the display

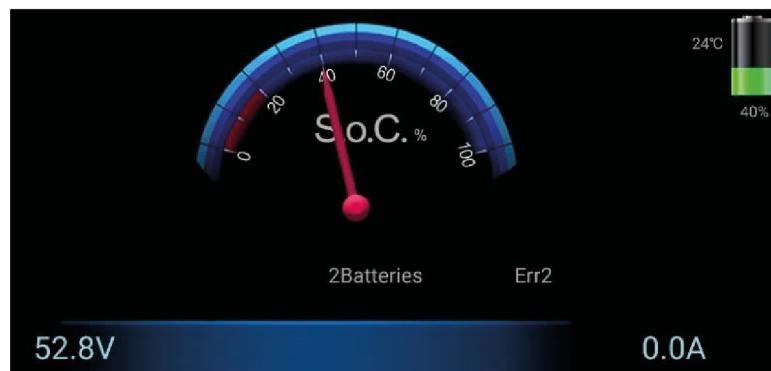

### 15. ERROR 3

Error 3 appears when one or more connected batteries have the BMS open during discharge (possible causes: too deep discharges, too high discharge currents or internal temperature outside the permitted limits). Always consult the datasheet and instructions for battery limits and BMS block management.

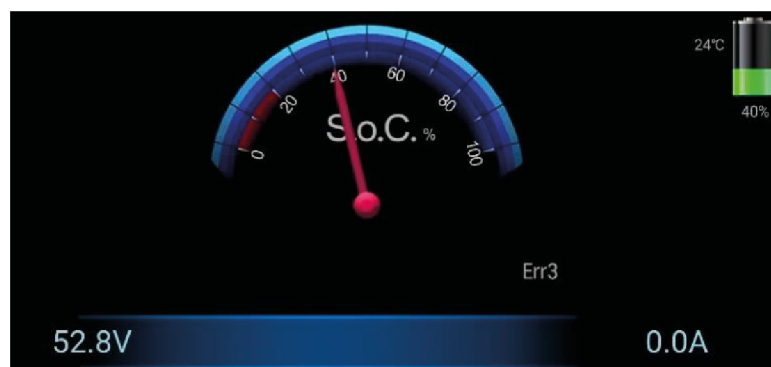



## 16. ERROR 4

Error 4 appears only when the fuse connected in series to each battery (if foreseen by the installer) opens during charging or discharging.

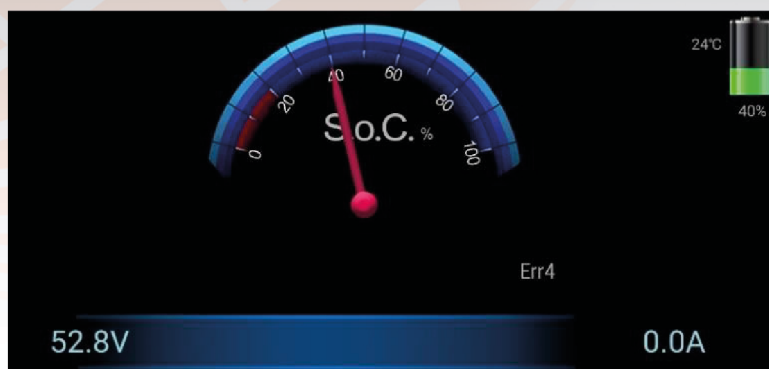

**NB: place the protection fuse on the positive polarity.**

## 17. ACCESSORIES

- ▶ Display for Zenith Lithium: **ZLIDISPLAY**
- ▶ Display connection cable - 1.5m battery: **ZLIDISPLAYCAB1.5**
- ▶ Display connection cable - 3m battery: **ZLIDISPLAYCAB3**
- ▶ Display connection cable - 6m battery: **ZLIDISPLAYCAB6**
- ▶ Display connection cable - 12m battery: **ZLIDISPLAYCAB12**
- ▶ Distribution connecting cables: **ZLISWITCH**